

# Lift Out LO

## Panel Orientation

### LO version

- Sliding panels – n/a
- Panels can be removed

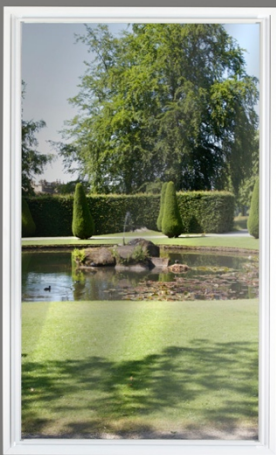

Closed



Panel Out

# Technical Information

## Panel Configuration

Simple removable panel which can be lifted in and out of the fixed frame as and when required.

## Panels removable

Yes

## Size

Min 250w x 300h, 4mm glass max 2000 x 2000, 6/6.8mm glass max *on application*  
(units over 1800mm in height will default to 6mm glass)

## Glass

Standard glass 4mm tough - Max glass thickness 6.8 laminate

## Thermal Performance: Variable

Standard 2.5 w/m<sup>2</sup>K / \*Low-E 1.8 w/m<sup>2</sup>K

## Acoustic Performance: Variable

Mid-Range Spec\* 48dB / High spec 51dB  
\*Certificated

## Specification

- All frames include PVC-U trim as standard – Painted PEFC timber available upon request.
- Aluminium 6063 T6 alloy to BS EN 755 standard, power coated to BS 6496 to 60 micron finish.
- Stock finishes: White – Interpon SA 098E high gloss, anodised.
- The sub-frame is manufactured from primed high quality, environmentally certified (MTCS) engineered timber.
- Standard sizes 45mm x 21mm & 62mm x 21mm.
- All Frames are factory glazed.
- Standard gasket colour is white.

In line with our company policy of continuous product development and improvement Clearview reserves the right to make minor alterations without notice.

## Optional Extras

- Black Gasket
- Locking Fitch Catch
- Chubb Lock
- Travel Limit Stop
- 25mm x 25mm box to support where stacked white aluminium coupling / stacking interlock
- Trickle vents / acoustic trickle vents
- RAL colour
- Fly screen
- Timber sizes other than standard

*Please scroll down for more information*

# Standard Frame Diagram - LO

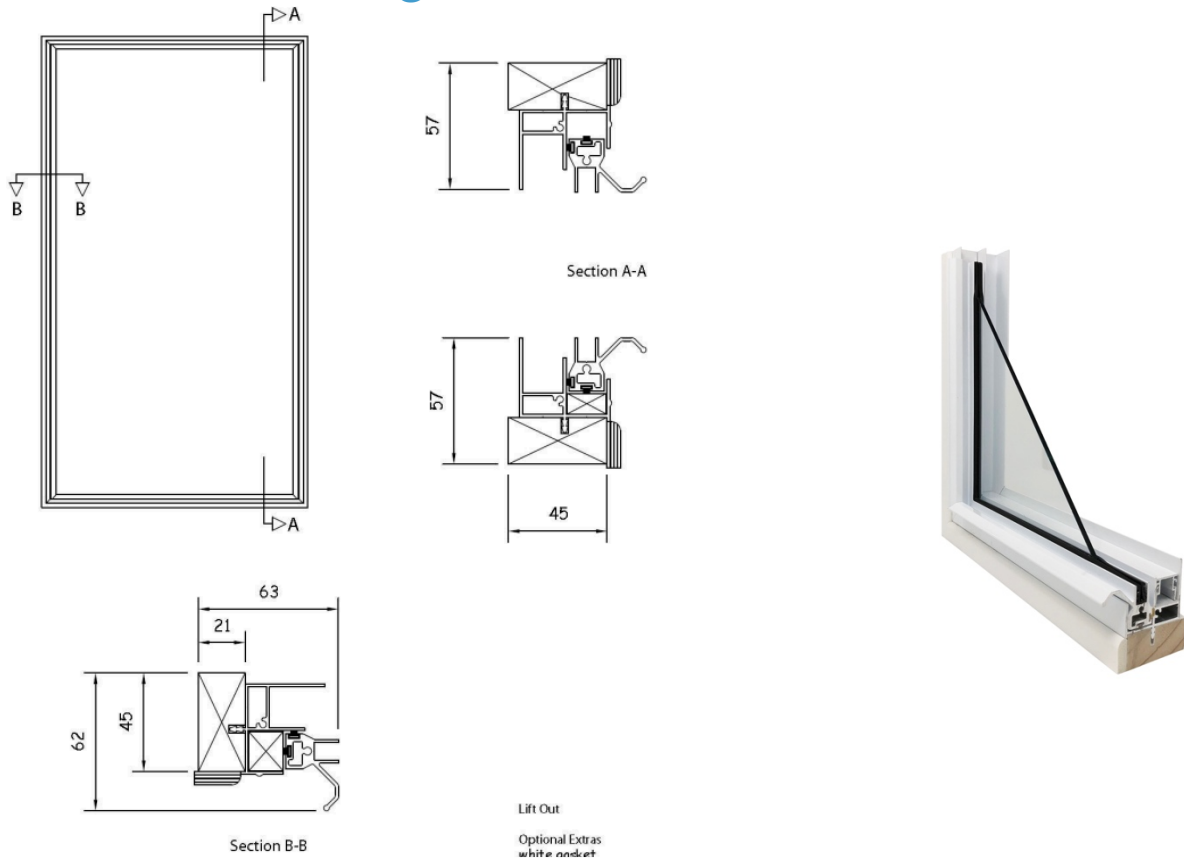

All units can be supplied in a Face or Reveal Fix drilled orientation.

Other Frame options available on Request.

## Fixing Options



Images are for representation purposes only and may differ from some product options.

# XL Frame Diagram

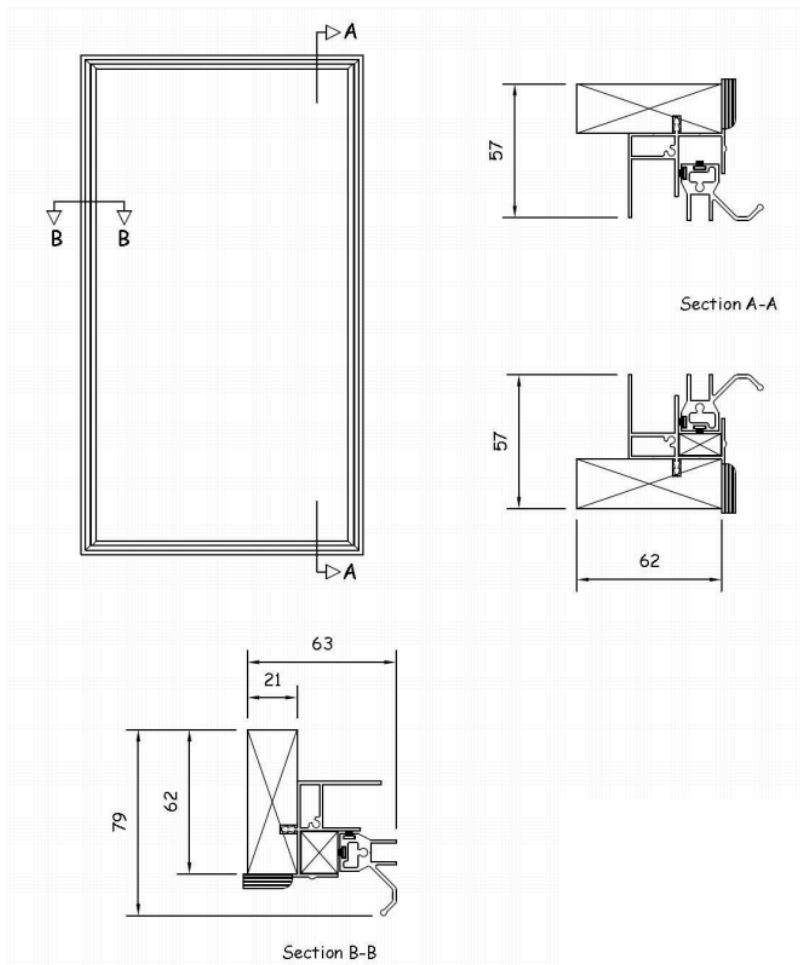

## Classic XL Frame Width Options

50 x 21      62 x 21      70 x 21      80 x 21      (other frames available on request)

The XL Frames give more stable installation when in a standalone reveal fix orientation. Smoother running of horizontal sliding panels. No visible screw heads in the aluminium tracks it will also increase the air-gap in a face fix orientation.

All units can be supplied in a Face or Reveal Fix drilled orientation.

## Fixing Options

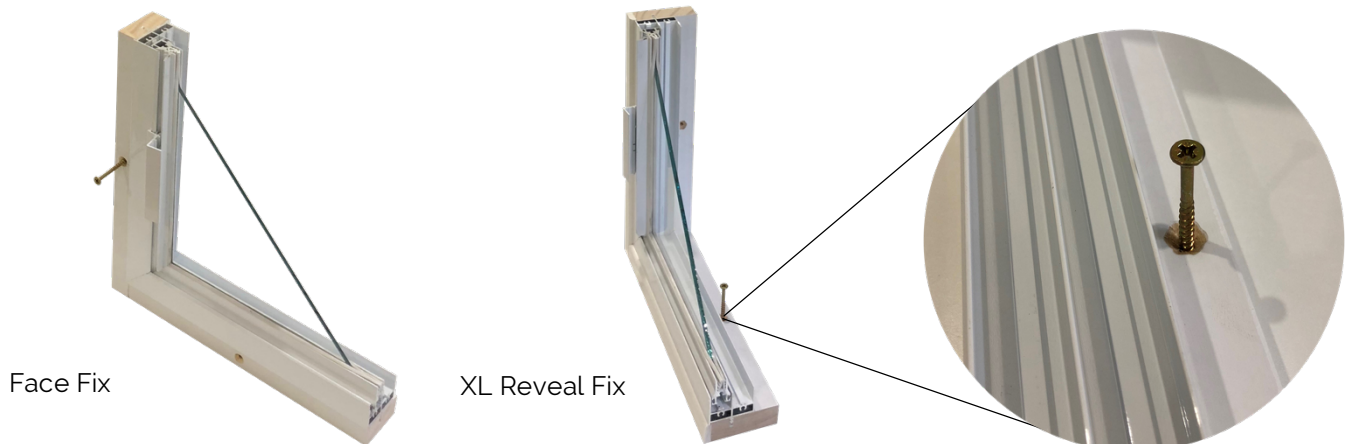

Images are for representation purposes only and may differ from some product options.

# Timber Modification Options

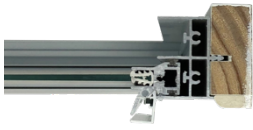

Standard Timber Option

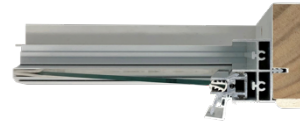

XL Timber Option



Bevelled Timber for Splayed Reveal



Example of Splayed Reveal



Angled Bay Bevelled Timber

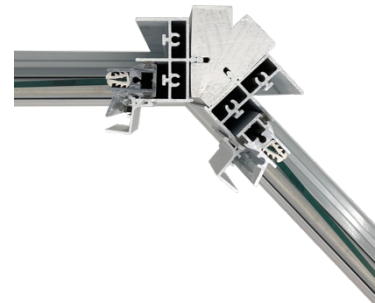

Angled Bay Connected Timbers



Square Bay Bevelled Timber

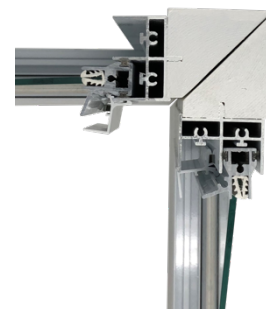

Square Bay Connected Timbers

*Images for illustration purposes only, demonstrating timber section detail*

## Frame Shape Options

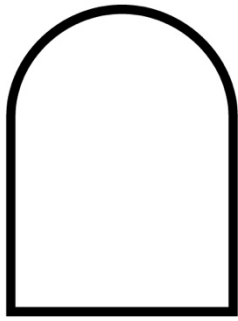

Standard Arch

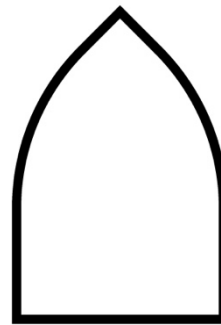

Gothic Arch

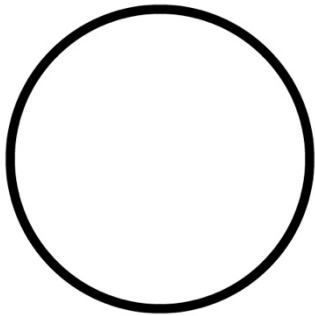

Round

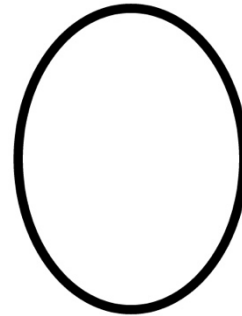

Oval

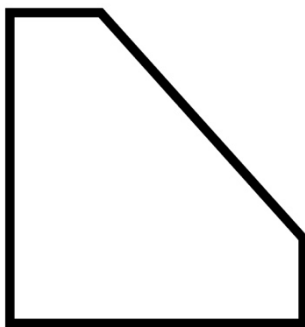

Chamfered

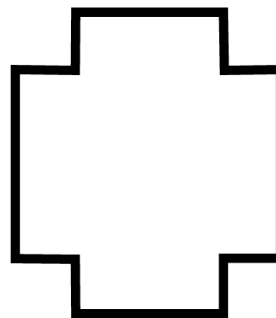

Notched \*

*\* Notched window showing 4 notches – notches are charged per notch*

*Templates are required from the customer*



Please get in touch with one of our friendly team today for help & advice.



Online Help Centre  
[Visit our Online Help Centre >>](#)



Fast Quote  
[Get a fast quote online >>](#)



Email  
[info@clearviewsg.co.uk](mailto:info@clearviewsg.co.uk)



Phone  
0114 294 5018

