

Insert Panel INS

Panel Only

- Simple Aluminium framed piece of glass.
- Screw fixed where required for a semi-permanent installation.
- Self Drilled onsite Face Fixing only.

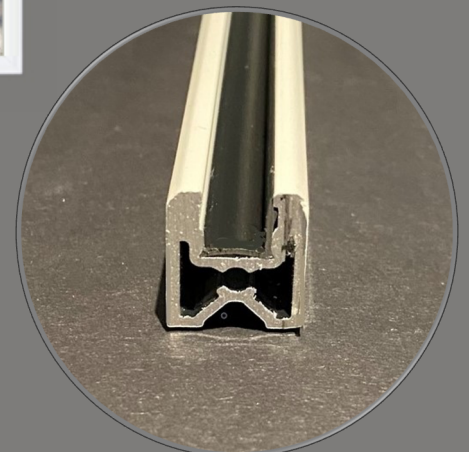
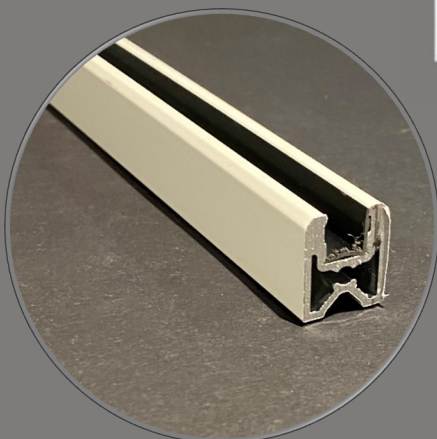

Technical Information

Panel Configuration

This is the most basic product we offer, a simple slim-line aluminium framed piece of glass to be fixed over a glazed area to create a double-glazed arrangement. e.g., deal for around door glass. Only attached in a face fix orientation. The panels are supplied without fixing holes, requiring the installer to drill the panel onsite. An adhesive draught seal compression tape can be applied to the back of the panel to compress and seal the frame on uneven surfaces or to increase overall seal integrity.

Panels removable

n/a, Face Fix Only.

Unit Build Size

Min 250mm x 300mm

Max. 4mm glass 1000mm x 1450mm

6mm to 10.8mm 2000mm x 2000mm (2000mm in one direction only)

Glass

Standard glass 4mm toughened – Standard frame maximum glass thickness 6.8mm

Ultra-Panel glass thickness: 8.8mm up to 10.8mm..

Thermal Performance: Variable

Standard 2.7 wm^2K / *Low-E 1.9 wm^2K

Acoustic Performance: Variable

Mid-Range Spec* 48dB / High spec 54dB, subject to glazing airgap.

Specification

- Aluminium 6063-T6 alloy BS EN 755-9 standard, power coated to BS 6496 to 60 - 80-micron finish
- 4mm toughened glass
- Stock finish: White – RAL 9003 Satin.
- Finishing Trim not provided
- Fixing holes drilled onsite by installer.
- All Frames are factory glazed.
- Standard gasket colour is white.

In line with our company policy of continues product development and improvement Clearview reserves the right to make minor alterations without notice.

Optional Extras

- Black Gasket
- Finishing Trim
- Alternative glass options.
- RAL colour options

Frame Details

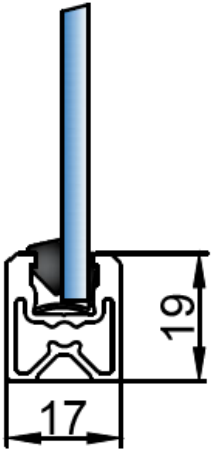

Standard Frame
4mm to 6.6mm glass sizes

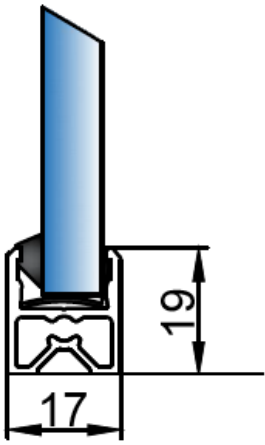

Ultra-Frame
8mm to 10.8mm glass sizes

Fixing Options

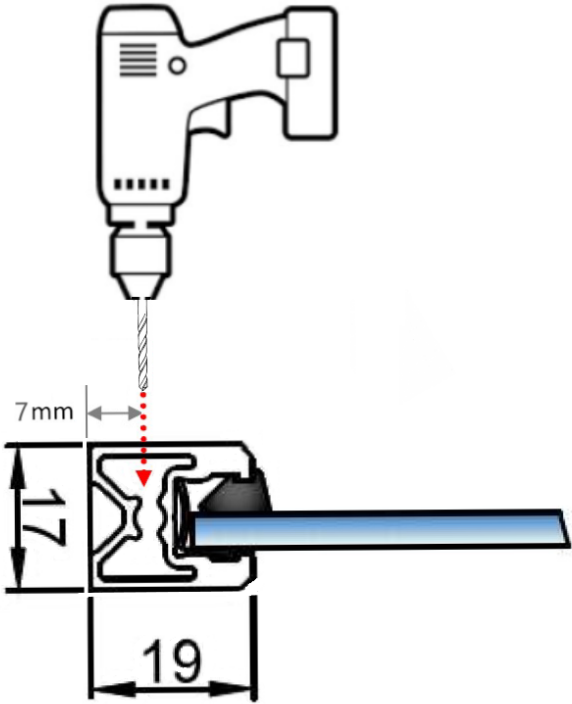

INS - Standard Frame Diagram

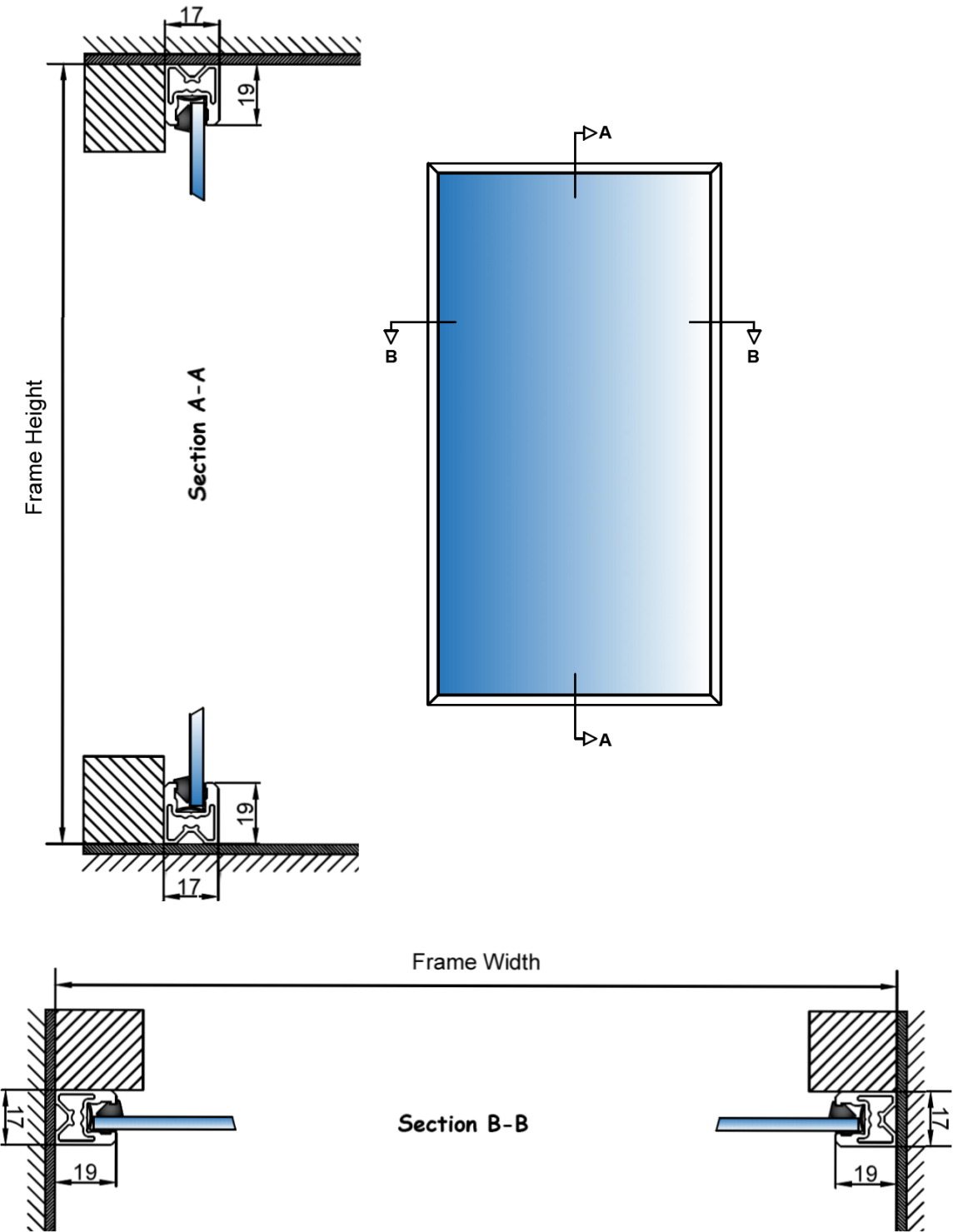

INS - Ultra Profile Diagram

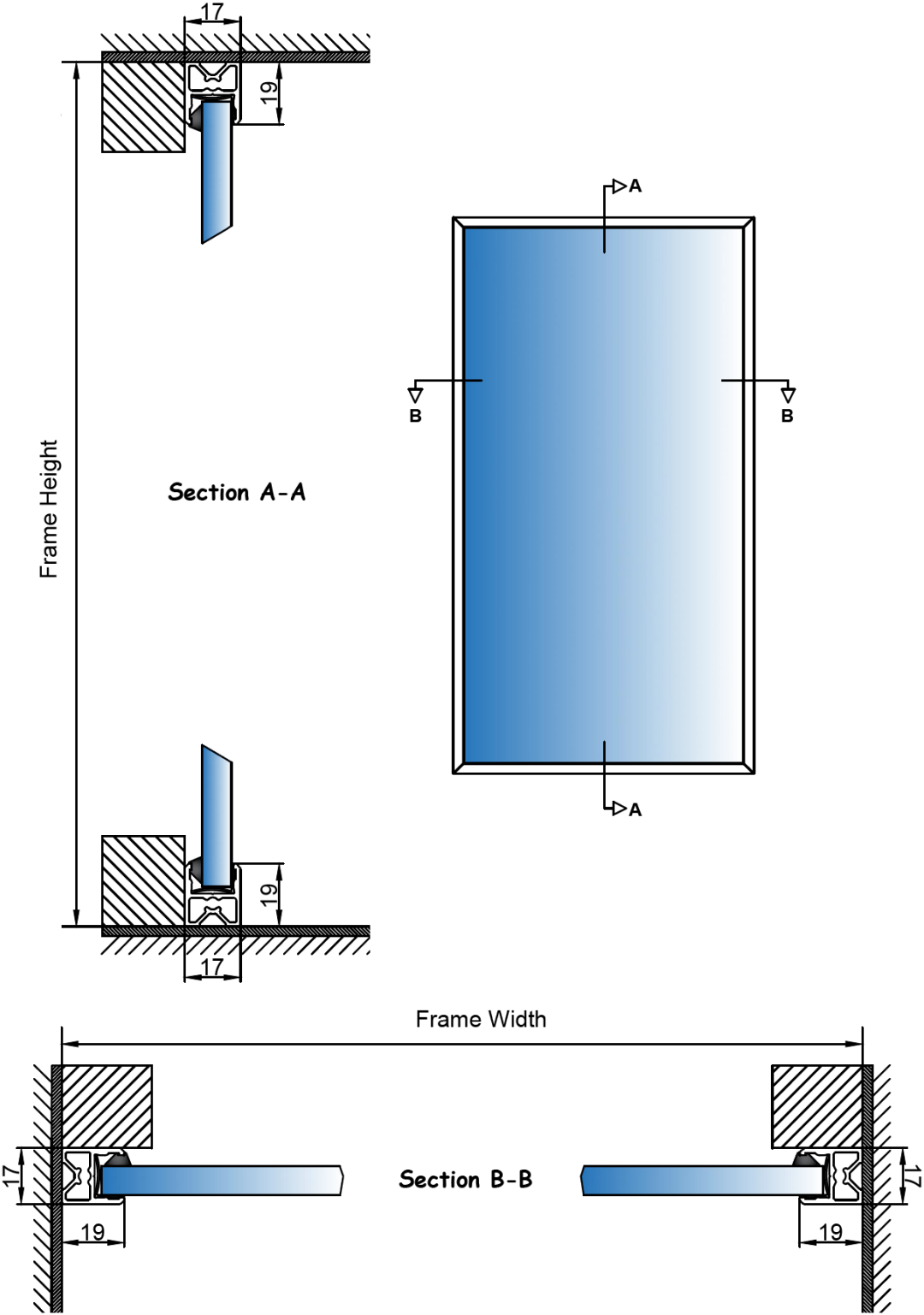

Frame Shape Options

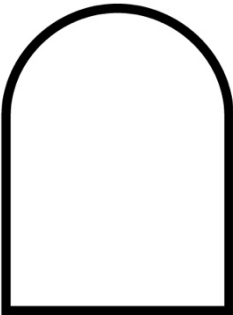

Standard Arch

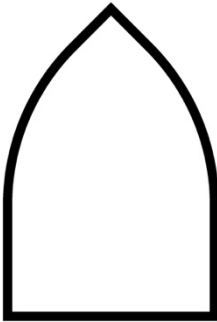

Gothic Arch

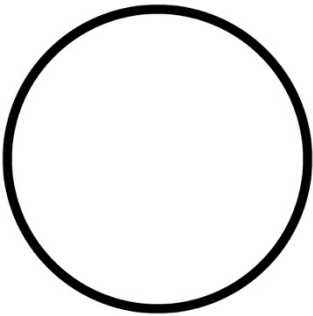

Round

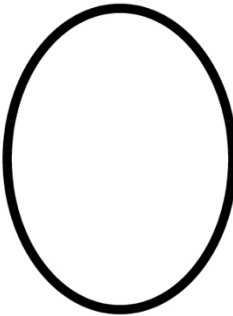

Oval

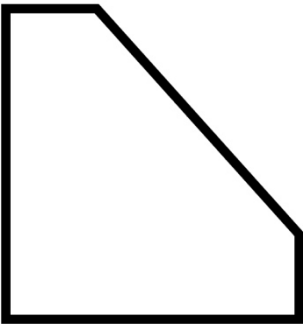

Chamfered

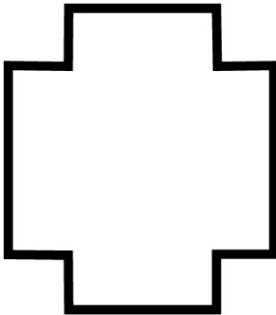

Notched

Notched window showing 4 notches – charged per notch

Templates may be required from the customer



Please get in touch with one of our friendly team today for help & advice.



Online Help Centre
[Visit our Online Help Centre >>](#)



Fast Quote
[Get a fast quote online >>](#)



Email
info@clearviewsg.co.uk



Phone
0114 294 5018

